

苏州国立净化材料有限公司  
SUZHOU NATIONAL PURIFICATION MATERIALS CO. LTD.

地址：苏州市吴江区汾湖金家坝金周路1635号  
电话 (Tel)：0512-63203385  
客服热线：400-833-6515  
传真 (Fax)：+86 512 68633128  
E-mail:szgjhcl@163.com  
阿里巴巴店铺：shop1459875475941.1688.com



# NATIONAL

## PURIFICATION TECHNOLOGY



# COMPANY CULTURE

我们的服务宗旨

**OUR SERVICE  
PURPOSES**

诚信 精诚所至，金石为开  
高效 急人所急，不误一秒  
严谨 精益求精，追求卓越  
创新 推陈出新，标新立异  
务实 脚踏实地，做事即做人  
态度 严于律己，精准求精





The National Group is committed to R&D, innovation, production and sales of clean technologies. Through 5-10 years of hard work, it will be among the well-known national brands. Our group has already invented its own patent for invention—high-efficiency filtration automatic production line—through the in-depth improvement of existing filtration technology and its sublimation. With a unique assembly line, our quality has become more stable and production efficiency has increased dramatically.

Our company is specialized in producing and manufacturing all kinds of pipeline mechanism choi steel, manual choi steel (polystyrene, polyurethane, rock wool, glass wool, glass magnesium plaster) have all kinds of cutting, punching, pressure, milling, grinding, welding, cutting and other dozens of machine tool; Successively introduced advanced processing equipment at home and abroad, including Japan murata company produces the hydraulic CNC turret multi-station punch, LVD CNC hydraulic shearing machine, LVD bending machine and other precision sheet metal processing equipment, set up a perfect production system.

# 公司简介 *COMPANY PROFILE*

国立集团致力于洁净技术的研发创新和生产销售。通过 5-10 年的努力，将跻身于知名的民族品牌之列。我集团通过对既有过滤技术的深度改良并升华，目前已经拥有了自己的发明专利—高效过滤自动生产线。拥有独一无二的流水线，我们的质量变得更加稳定，生产效率大幅提高。

我司专业生产、制造各类流水线机制彩钢板、手工彩钢板（聚苯乙烯、聚氨酯、岩棉、玻璃棉、玻镁石膏）已经拥有各种剪、冲、压、铣、磨、焊、线切割等各种机床数十台；先后引进了国内外先进的加工设备，包括日本村田公司生产的液压数控转塔多工位冲床、LVD 数控液压力式剪板机、LVD 折弯机等精密钣金加工设备，建立起一套完善的生产体系。





# TABLE OF CONTENTS

## 目录 TABLE OF CONTENTS

---

 <b>企业文化</b> ..... 01 <i>COMPANY CULTURE</i>
 <b>公司简介</b> ..... 03 <i>COMPANY PROFILE</i>
 <b>机制夹芯板</b> ..... 07 <i>MACHINE MADE SANDWICH PLATE</i>
 <b>手工复合板</b> ..... 17 <i>HANDMADE COMPOSITE PLATE</i>
 <b>净化板材拼接方式</b> ..... 25 <i>PURIFICATION OF SHEET METAL STITCHING</i>
 <b>净化产品</b> ..... 29 <i>PURIFICATION PRODUCTS</i>
 <b>售后服务</b> ..... 37 <i>AFTER-SALE SERVICE</i>

## 产品简介 CORPORATE CULTURE

### 主要产品

- 岩棉彩钢夹芯板
- 聚苯乙烯彩钢夹芯板
- 中空玻镁复合板
- 中空玻镁岩棉夹芯板
- 聚氨脂(PU)彩钢夹芯板
- 硅岩彩钢夹芯板
- 纸蜂窝彩钢夹芯板
- 烘道岩棉夹芯板



产品系半机械结合手工生产，有岩棉彩钢板、玻镁岩棉彩钢板、玻镁彩钢板、硅酸铝棉彩钢板、聚氨酯彩钢板、铝（纸）蜂窝彩钢板。可根据客户及需方工程要求制作特殊芯材、特殊规格的板材，组合安装，且能多次拆装，施工安装方便，综合效果十分显著。产品钢面为高级聚酯烘烤涂层、铝锌涂层、不锈钢板，故耐腐蚀性特好；产品内填材料均系A级难燃材料，燃烧时不会熔断，也无高温分解滴落物，是目前国内高等级的防火建筑装饰复合板，产品强度高、耐冲击、抗震性好。具有表面光滑美观、强度高、隔音、绝热、保温、抗震、尺寸可定制、连接方便、拆卸容易、芯材不外露、施工方便等性能。广泛用于高科技电子、医药、化工、食品等行业的净化房围护、吊顶，工业厂房、仓库、冷库、烤炉、空调器壁板等洁净领域。

It is manufactured by the combination of semi-mechanization and handwork, including rock wool color steel plate, glass magnesium rock wool color steel plate, glass magnesium color steel plate, aluminum silicate wool color steel plate, polyurethane color steel plate and aluminum (paper) honeycomb color steel plate. In accordance with engineering requirements from customers and demanding party, the Company can fabricate special sandwich materials and plates with special specification which can be installed by combination and dismantled/mounted for many times, characterized by easy construction installation and obvious comprehensive effect. Its steel surface adopts high grade polyester baking coating, aluminum-zinc coating and stainless steel plate with good corrosion resistance; with Grade A flame retardant substances as filling material, it will have no breakage and dripping caused by high temperature decomposition during burning. As a kind of fire-proof building decoration composite plate with high grade in China, it is characterized by high strength, good impact resistance, excellent shock resistance, smooth and beautiful surface, sound insulation, thermal insulation, heat preservation, customized size, easy connection, convenient dismantling/mounting, no exposure of sandwich material, easy construction, etc.

It is widely used for clean room shield, suspended ceiling, industrial factory building, warehouse, refrigeration house, oven, air conditioner wall plate, etc. in hi-tech electronic, medical, chemical and food industries as well as various clean fields.

## 机制夹芯板

MACHINE MADE  
SANDWICH PLATE



## ROCK WOOL COLOR STEEL SANDWICH PANEL 岩棉彩钢夹芯板

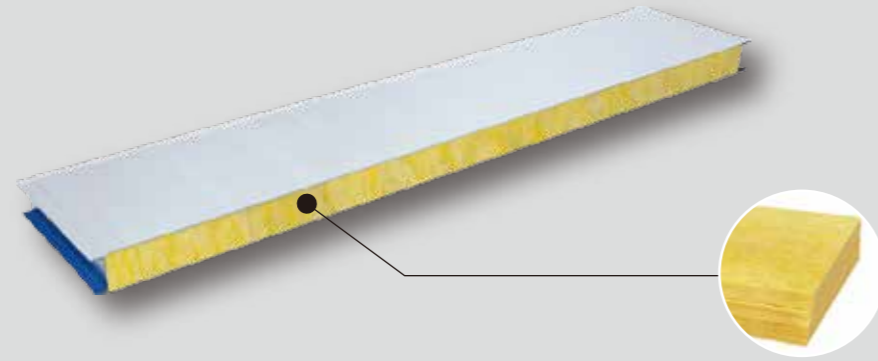

### 规格：

宽度：950mm、1150mm  
厚度：50mm、75mm、100mm、150mm、200mm  
型式：企口板、瓦楞夹芯板（平板、压型）  
消防等级：A级

### 产品介绍：

采用中高密度岩棉为芯材，镀锌（不锈钢）或彩涂钢板为面层结合高强度粘剂，通过高速连续自动化成型机加温、加压复合，经过修边、开槽、下料而成的新一代建筑装潢板材，具有保温隔热、安装便捷的特点。  
适用于洁净房、无尘车间、防爆防火车间吊顶、隔断等，同时适用于烘房、烤漆房、工业设备、建筑、船舶的绝热、隔音等。

### SPECIFICATION:

Width: 950mm; 1150mm.  
Thickness: 50mm;75mm;100mm;150mm;200mm.  
Connector Type: Tongued and Grooved; Corrugated(smooth and pressed)  
Fireproof: Lever A

### PRODUCT INTRODUCTION:

Middle and high density rock wool (glass wool) core material, galvanized (stainless steel) or color coated surface layer and high-strength adhesive, be heating, pressurized composite, then trimming, grooving, cutting by high-speed continuous automatic molding machine to form a new generation of construction and decoration sheet, which has feature of good insulation, convenient installation.

It is widely be used for clean rooms, clean workshops, riot fire workshop ceilings, partitions etc.,And also can be used as heat and sound insulation material for drying rooms, paint rooms, industrial equipment, buildings, ships and so on.

## EPS SANDWICH PANEL 聚苯乙烯彩钢夹芯板

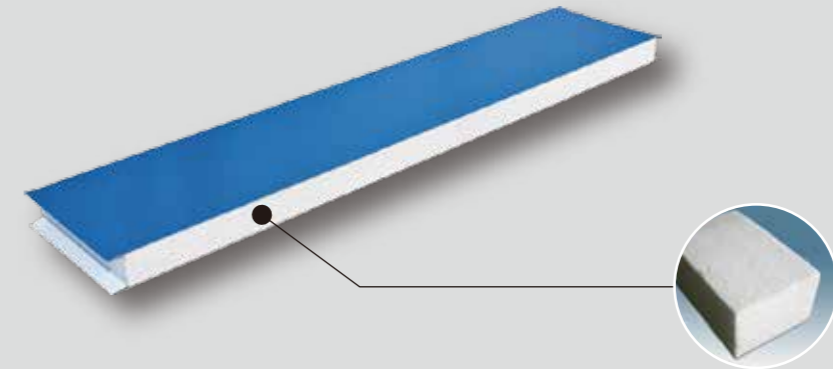

### 规格：

宽度：950mm、1150mm  
厚度：50mm、75mm、100mm  
型式：企口板、H板  
消防等级：B级  
氧指数(Oi)：34.0，密度：12-24kg/m3

### 产品介绍：

采用阻燃型EPS为芯材，镀锌（不锈钢）或彩涂板钢为面层结合高强度粘剂，通过高速连续自动成型机加温、加压复合，经过修边、开槽、下料而成的新一代建筑装潢板材。  
广泛用于电子、生物、食品、制药、医院、军事等洁净建筑领域，尤其适用于生产车间和仓库。

### SPECIFICATION:

Width: 950mm; 1150mm  
Thickness: 50mm; 75mm; 100mm  
Connector Type: Tongued and Grooved; H form  
Fireproof: Lever B  
OI(oxygen index): 43.0 Capacity: 12-24kg/m3

### PRODUCT INTRODUCTION:

Flame retarding EPS(Polystyrene) core material, galvanized(stainless steel)or pre-painted galvanize color sheet surface layer, be heated and pressing compounded in high speed continuous molding machine to new generation decorative material.

It is widely used in clean buildings like electronics, food, pharmaceuticals, hospitals, military etc. especially applied in high standard workshop and warehouse.

## HOLLOW GLASS MAGNESIUM PANEL 中空玻镁复合板

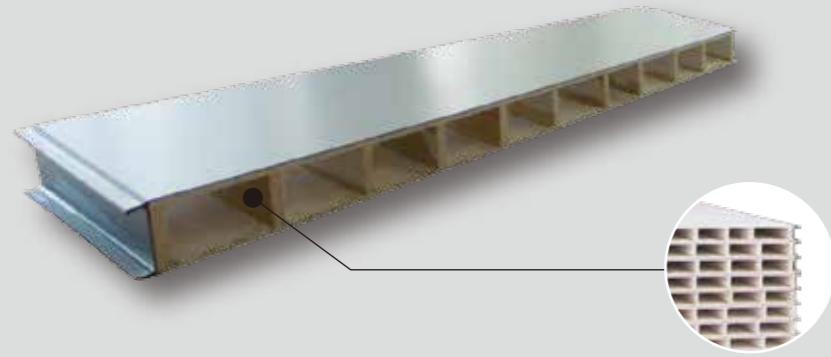

### 规格：

宽度：950mm、1150mm  
厚度：50mm、75mm、100mm  
型式：企口板  
消防等级：A级

### 产品介绍：

以彩色涂层钢板为面材，以中空玻镁为芯材，用热固化胶在连续成型机内加压复合而成的轻质建筑板材。玻镁板是以氧化镁，氯化镁，和水三元体系，经配置和加改性剂而制成的，性能稳定的镁质胶凝材料，以中碱性玻纤网为增强材料，以轻质材料为填充物复合而成的新型不燃性装饰材料。

采用特殊生产工艺加工而成，具有防火、防水、无味、无毒、不冻、不腐、不裂、不变、不燃、高强质轻、施工方便、使用寿命长等特点。

### SPECIFICATION:

Width: 950mm; 1150mm  
Thickness: 50mm; 75mm; 100mm  
Connector Type: Tongued and Grooved  
Fireproof: Lever A

### PRODUCT INTRODUCTION:

Pre-painted galvanized steel sheet surface, hollow glass magnesium core material, be pressing compounded to light building material in continuous molding machine with thermal curing glue.

Processed by special technology, enable it featured with fireproofing, waterproofing, tasteless, Non-toxic, ice-free, stale proofing, crack-proof, non-deformation, non-inflammable, high-strength and light weight, construction easy. And with long life time.

## HOLLOW GLASS MAGNESIA CORE BOARD 中空玻镁岩棉夹芯板

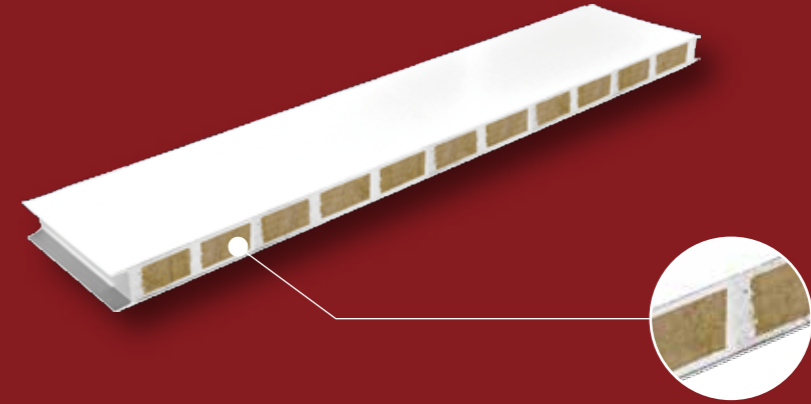

### 规格：

宽度：950mm、1150mm  
厚度：50mm、75mm、100mm  
型式：企口板  
消防等级：A级

### 产品介绍：

以彩色涂层钢板为面材，用5mm玻璃镁板为上下芯层，岩棉为内芯层，通过加压、加热等工序制造而成，密封性能好，防火等级高。采用特殊生产工艺加工而成，具有防火、防水、无味、无毒、不冻、不腐、不裂、不变、不燃、高强质轻等特点。

### SPECIFICATION:

Width: 950mm; 1150mm  
Thickness: 50mm; 75mm; 100mm  
Connector Type: Tongued and Grooved  
Fireproof: Lever A

### PRODUCT INTRODUCTION:

Pre-painted galvanized steel sheet surface, 5mm glass magnesium core material, and rock wool insulation, be processed by pressing, heating to high airtight and high fire rate sheet.

Processed by special technology, enable it featured with fireproofing, waterproofing, tasteless, Non-toxic, ice-free, stale proofing, crack-proof, non-deformation, non-inflammable, high-strength and light weight.

## POLYURETHANE (PU) COLOR STEEL SANDWICH PANEL 聚氨酯(PU)彩钢夹芯板

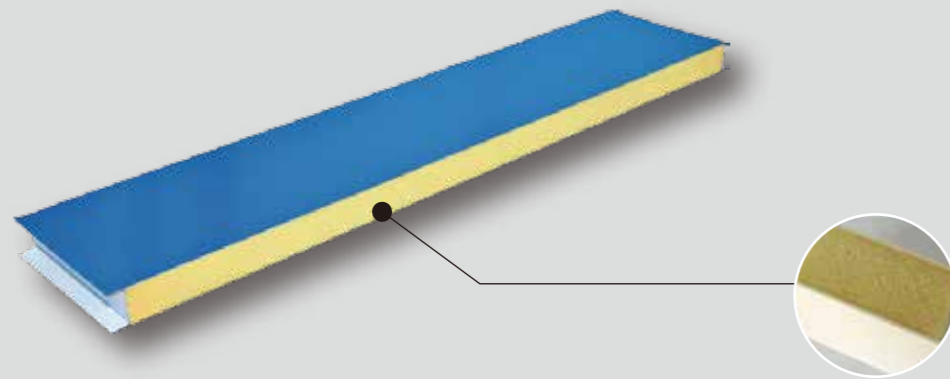

### 规格：

宽度：950mm、1150mm  
厚度：50mm、75mm、100mm  
型式：企口板  
消防等级：B级  
密度：30~40 ( kg/m<sup>3</sup> )

### 产品介绍：

采用聚氨酯PU为芯材，镀锌（不锈钢）或彩涂板钢为面层结合高强度粘剂，通过高速连续自动成型机加热、加压复合，经过修边、开槽、下料而成的新一代建筑装饰板材。

广泛用于电子、生物、食品、制药、医院、军事等洁净建筑领域，尤其适用于高洁净级别的生产车间和仓库。

### SPECIFICATION:

Width: 950mm; 1150mm  
Thickness: 50mm; 75mm; 100mm  
Connector Type: Tongued and Grooved  
Fireproof: Lever B  
Capacity: 30-40kg/m<sup>3</sup>

### PRODUCT INTRODUCTION:

PU(Polyurethane) core material, galvanized(stainless steel)or pre-painted galvanize color sheet surface layer, be heated and pressing compounded in high speed continuous molding machine to new generation decorative material.

It is widely used in clean buildings like electronics, food, pharmaceuticals, hospitals, military etc. especially applied in high standard workshop and warehouse.

## ROCKWOOL SANDWICH PANEL 硅岩彩钢夹芯板

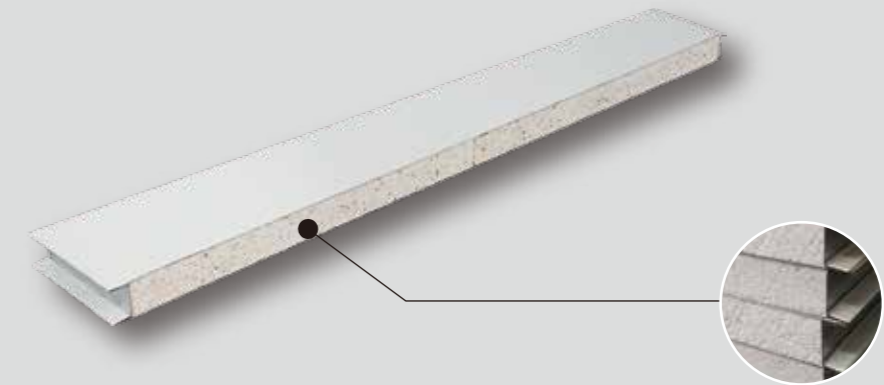

### 规格：

宽度：950mm、1150mm  
厚度：50mm、75mm、100mm、150mm  
型式：H板（平板、压型）、企口板、瓦楞夹芯板  
颜色：按工程要求选取  
长度：按工程要求及运输条件定做

### 产品介绍：

采用硅岩为芯材，镀锌或彩涂板为面层（两层）及高强度粘剂，通过高速连续自动化成型机加热、加压复合，经过修边、开槽、下料而成的新一代建筑装饰板材，具有保温隔热、安装便捷的特点。是同类（夹芯板系列）中耐火性能最强的一种新型防火板材。

适用于烘房、烤漆房、工业设备、建筑、船舶的绝热、隔音等，同时适用于电子洁净房、净化房、防爆防火车间吊顶、隔断等。

### SPECIFICATION:

Width: 950mm, 1150mm  
Thickness: 50mm, 75mm, 100mm, 150mm  
Type: H plate (flat, pressure type), Qi mouth board, corrugated sandwich panels  
Color: Select according to project requirements  
Length: Customized according to engineering requirements and transportation conditions

### PRODUCT INTRODUCTION:

The use of silicon as the core material, galvanized or color coated board for the surface layer (two layers) and high-strength adhesive, through high-speed continuous automatic molding machine heating, pressure composite, after trimming, slotting, A new generation of architectural decoration sheet, with thermal insulation, easy installation features. Is the same type (sandwich panel series) in the fire resistance of the strongest of a new type of fire board.

Applicable to drying room, paint room, industrial equipment, construction, ship insulation, noise, etc., at the same time for electronic clean room, clean room, anti-riot fire shop ceiling, cut off and so on.



## PAPER-HONEYCOMB SANDWICH PANEL 纸蜂窝彩钢夹芯板

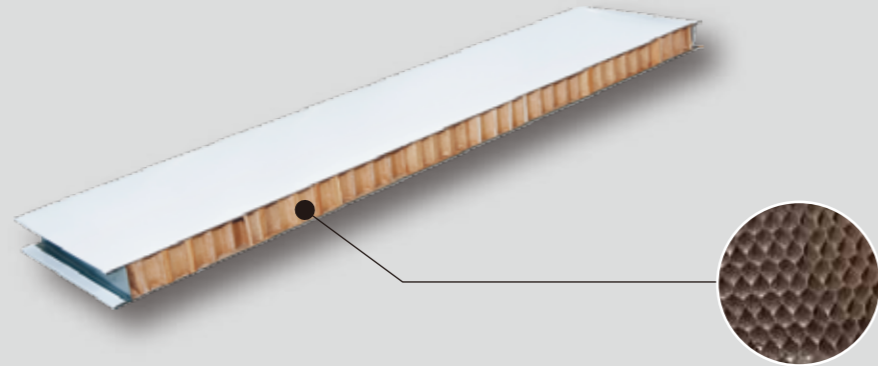

### 规格：

宽度：950、1150mm  
厚度：50、75、100、150、200mm  
长度：按工程要求及运输条件定做  
颜色：按工程要求选取  
品种：H板（平板、压型）、企口板、瓦楞夹芯板

### 产品介绍：

纸蜂窝夹芯钢板是以彩色涂层为面板，以纸蜂窝为芯材，用热固化胶在连续成型机内加热加压复合而成的超轻建筑板材。产品自重轻、保温隔热性能好、隔声效果好、施工速度快。广泛用于电子、生物、食品、制药、医院、军事等洁净建筑领域，尤其适用于高洁净级别的工业生产车间。

### SPECIFICATION:

Width: 950, 1150 mm  
Thickness: 50, 75, 100, 150, 200 mm  
Length: customized according to project requirements and conditions of transport  
Color: select the engineering requirements  
Varieties: H-plate (plate, pressure type), tongue and groove boards, corrugated sandwich panels

### PRODUCT INTRODUCTION:

Paper honeycomb sandwich color plate is a color coating for the panel to paper honeycomb as the core material, with heat curing adhesive in the continuous molding machine heating and pressing compound made of ultra-light construction plate. Product light weight, insulation cut off the good performance, sound insulation effect is good, construction speed.

Widely used in electronics, biotechnology, food, pharmaceutical, hospital, military and other clean construction areas, especially for high clean level of industrial production workshop.

## DRYING ROCK WOOL SANDWICH PANELS 烘道岩棉夹芯板

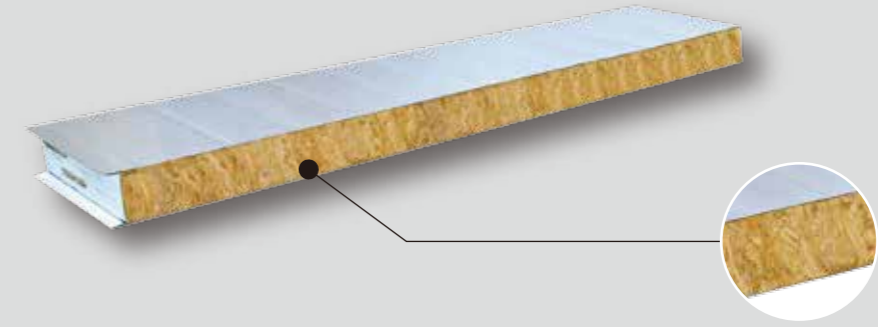

### 规格：

宽度：950、1150mm  
厚度：50、75、100、150mm  
长度：按工程要求及运输条件定尺  
颜色：按工程要求选取  
品种：H板（平板、压型）、企口板、瓦楞夹芯板

### 产品介绍：

在岩棉钢板传统的基础上，开发的冲孔式岩彩钢板，专门为烘房、烤漆房等室内有高温作业环境需要所制作，克服了钢带传输冷媒散热的影响，能够有效地控制室内温度热量的散发。该产品适用于烘房、烤漆房、涂装烘道、工业设备、建筑、船舶的绝热、隔音、防爆防火车间吊顶、隔断等。

### SPECIFICATION:

Width: 950, 1150mm  
Thickness: 50, 75, 100, 150, 200mm  
Length: according to the engineering requirements and transport conditions  
Color: Select according to project requirements  
Variety: H plate (flat, pressure type), Qi mouth board, corrugated sandwich panels

### PRODUCT INTRODUCTION:

On the basis of the tradition of rock wool color plate, the development of punching-type rock color steel plate, specifically for the drying room, paint room and other indoor high temperature operating environment needs to be produced to overcome the cooling effect of steel conveyor cooling, can effectively control the indoor temperature Heat dissipation.

The product is suitable for drying room, paint room, coating drying Road, industrial equipment, construction, ship insulation, noise, explosion-proof fire shop ceiling, partition and so on.



## 产品简介

## CORPORATE CULTURE



### 主要产品

- 岩棉手工夹芯板
- 石膏岩棉手工夹芯板
- 玻镁岩棉手工夹芯板
- 纸蜂窝手工夹芯板
- 铝蜂窝手工夹芯板
- 聚氨酯手工夹芯板
- 中空玻镁手工夹芯板
- 玻镁纸蜂窝手工夹芯板
- 玻镁铝蜂窝手工夹芯板
- 硅岩手工夹芯板
- 沸腾石手工夹芯板
- 酚醛手工夹芯板

## 手工复合板

## HANDMADE COMPOSITE PLATE

夹芯板产品是由两层成型金属面板（或其他材料面板）和直接在面板中间发泡、熟化成型的高分子隔热内芯组成。填充系统使用的也是闭泡分子结构，可以杜绝水汽的凝结。外层钢板的成型充分考虑了结构和强度要求，内面层成型为平板以适应各种需要。夹芯板外形美观，色泽艳丽，整体效果好，它集承重，保温，防火，防水于一体，且无需二次装修。它用途广泛，特别适用于建筑工地的临时办公室、仓库、围墙等。在快速安装投入使用、可装可拆、材料的重复使用指数方面，都有明显优势，较大幅度降低建筑工地临时设施费用，是不可缺少的新型轻质建筑材料。

It is composed by two layers of metal forming plates (or other materials) and polymer thermal insulation inner core which directly makes foaming and cured forming between two plates. Closed cell structure is used for filling system to avoid moisture condensation. Forming of external layer of steel plate fully considers structure and strength requirements and internal layer is formed into flat plate to meet various demands. With beautiful appearance, bright color and good overall effect, it integrates load-bearing, thermal insulation, fire-proof and water-proof as a whole and needs no secondary decoration. It can be used widely, especially for temporary office, warehouse, fence, etc. on the construction site. It has remarkable advantages on quick installation, mounting/dismounting and repeated use for materials. In addition, it can greatly reduce temporary facility cost on the construction site as a kind of necessary new lightweight building material.



## ROCK WOOL HAND SANDWICH BOARD 岩棉手工夹芯板

### 产品介绍：

- 构成：双层钢板，内衬岩棉（矿棉），采用手工工艺制作。岩棉又称岩石棉，主要成分为玄武岩，是一种以天然岩石及矿物质等原料制成的蓬松状短细纤维，不可燃。
- 优点：防火性能好，隔音绝热性能高。
- 应用：广泛应用于食品、医药、电子、科研、航天、医药等行业的厂房、实验室及各种场所的隔断、吊顶。

### PRODUCT INTRODUCTION:

- Composition: double steel sheet, insulation rock wool/mineral wool, hand-made craft. Rockwool, also known as rock wool, its fluffy short fine fibers made of natural rock main components is basalt, non-inflammable.
- Advantages: good fireproofing performance, high noise insulation.
- Application: widely used as wall, partition and ceiling in workshop, laboratory in the field of food, pharmaceutical, electronics, scientific research, aerospace, medical and so on.



## GLASS WOOL SANDWICH BOARD 玻镁岩棉手工夹芯板

### 产品介绍：

- 手工双面玻镁岩棉夹芯板，采用优质彩色涂层钢板为面层，用镀锌钢带为封边件及加强筋，用防潮玻镁板为芯层，岩棉为内芯层，通过加压、加热等工序制造而成，密封性能好，防火等级高。本产品施工安装方便快捷，综合效益十分显著。主要应用于电子（工业厂房）医药（净化房）化工（防火车间）广泛应用于食品、医药、电子、科研、航天、医药等行业的厂房、实验室及各种场所的隔断、吊顶。

### PRODUCT INTRODUCTION:

- Handmade magnesium rock wool composite panel, high quality pre-painted galvanized as steel sheet surface, galvanized steel side cover and reinforcing rib, moisture proof glass magnesium as core material, and rock wool as insulation, be processed by pressing, heating to high airtight and high fire rate sheet. Easy installation.
- widely used as wall, partition and ceiling in workshop, laboratory in the field of food, pharmaceutical, electronics, scientific research, aerospace, medical and so on.

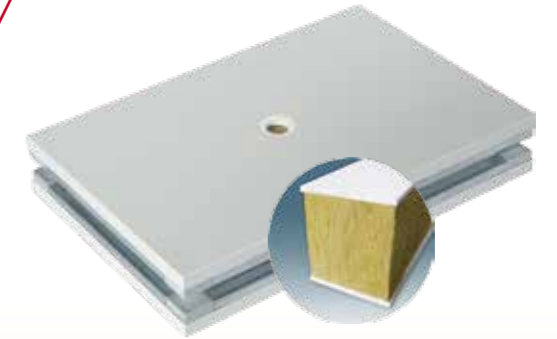

## GYPSUM ROCK WOOL HANDMADE SANDWICH PANELS 石膏岩棉手工夹芯板

### 产品介绍：

- 构成：手工石膏岩棉夹芯板，采用优质彩色涂层钢板为面层，芯材采用石膏板、岩棉，四周采用铁质龙骨框或铝合金冷拉型雌雄口框，手工制作而成。
- 优点：防火性能好、强度较高、隔音绝热性高。
- 应用：广泛应用于食品、制药、电子、科研、航天、医疗等行业的厂房、实验室及各种场所功能性隔断及吊顶。

### PRODUCT INTRODUCTION:

- Composition: Handmade gypsum, rock wool sandwich board, the use of high-quality color coated steel plate for the surface, the core material used gypsum board, rock wool, surrounded by iron keel or aluminum alloy cold drawn type, male and female frame, handmade.
- Advantages: good fire resistance, high strength, sound insulation, high heat insulation.
- Applications: widely used in food, pharmaceutical, electronics, scientific research, aerospace, medical and other industries in factories, laboratories and various places functional separation and ceiling.

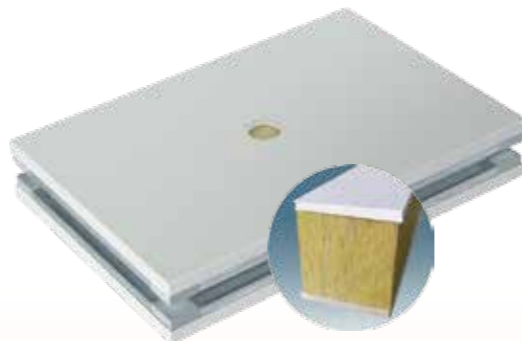

## HANDMADE PAPER-HONEYCOMB COMPOSITE PANEL 纸蜂窝手工夹芯板

### 产品介绍：

- 手工纸蜂窝夹芯板，采用优质彩色涂层钢板为面层，内夹阻燃性纸蜂窝芯材，采用手工制作工艺。四周采用铝合金龙骨或铁制龙骨框。
- 本产品施工安装方便快捷，综合效益十分显著。广泛应用于食品、制药、电子、科研、航天、医疗等行业的厂房、实验室及各种场所功能性隔断及吊顶。特别适用于高洁净区域，是目前洁净厂房推广的环保型板材。

### PRODUCT INTRODUCTION:

- Handmade paper honeycomb sandwich panels, the use of high-quality color coated steel for the surface layer, within the folder flame retardant paper honeycomb core material, using hand-made process. Surrounded by aluminum alloy keel or iron keel frame.
- This product construction and installation convenient, comprehensive benefits are very significant. Widely used in food, pharmaceutical, electronics, scientific research, aerospace, medical and other industries of the plant, laboratory and various places functional partition and ceiling. Especially for high clean area, is the current clean room to promote the environment-friendly sheet.

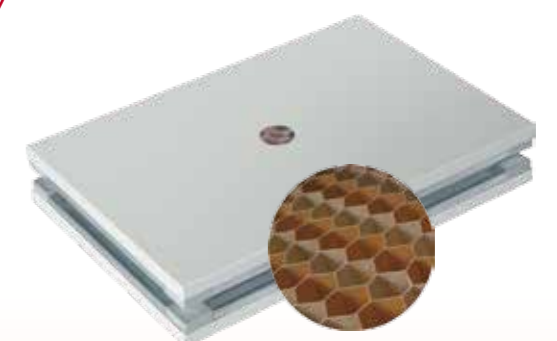

## ALUMINUM HONEYCOMB HANDMADE SANDWICH PANELS 铝蜂窝手工夹芯板

### 产品介绍：

手工铝蜂窝夹芯板，采用优质彩色涂层钢板为面层，用铝蜂巢为芯层，遵循严格的加工工艺，经过加压、加热、开槽等工序、制造而成。

与其它夹芯板相比，它具有重量轻，平直度好，外形美观，节点科学，隔音绝热性好、防火性能好，安装方便等特点。因其芯材采用独特六边形结构，具有高抗压强度，张力好、重量轻，属于绿色环保建材。

### PRODUCT INTRODUCTION:

Handmade aluminum honeycomb sandwich panels, the use of high-quality color coated steel for the surface layer, with aluminum honeycomb for the core layer, follow the strict processing technology, after pressurization, heating, slotting and other processes,

Compared with other sandwich panels, it has a light weight, flatness is good, beautiful appearance, node science, good insulation, good fire performance, easy installation and so on. Because of its core material using a unique hexagonal structure, with high compressive strength, good tension, light weight, are green building materials.

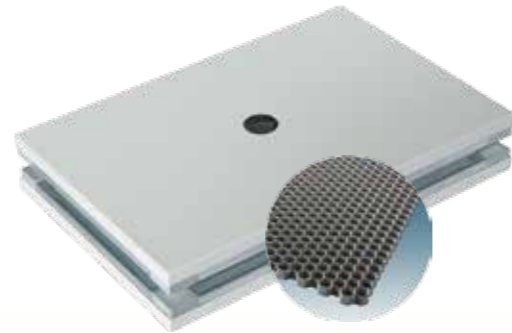

## HANDMADE HOLLOW MAGNESIUM COMPOSITE PANEL 中空玻镁手工夹芯板

### 产品介绍：

- 中空玻镁彩钢板双面采用彩涂/氟碳/镀锌/抗静电钢板（厚度0.18MM-1.2MM）；
- 芯材为无机质玻镁板（耐火、防潮），是我公司新开发的彩钢板产品；
- 四周采用铝合金冷拉型框架或塑钢框；
- 产品具有表面美观、隔音、绝热、保温、抗震，防火性能符合国家标准。

### PRODUCT INTRODUCTION:

- The hollow glass magnesium choi steel using double-sided painted/fluorine carbon/aluminium/antistatic zinc steel plate (the thickness of 0.18 MM to 1.2 MM);
- The core material for inorganic qualitative glass magnesium board (fireproof, moistureproof), is my company's newly developed choi steel products;
- Aluminum alloy cold drawn around the frame or plastic box;
- Products with a surface appearance, sound insulation, heat insulation, thermal insulation, seismic, fireproof performance meet the national standards.

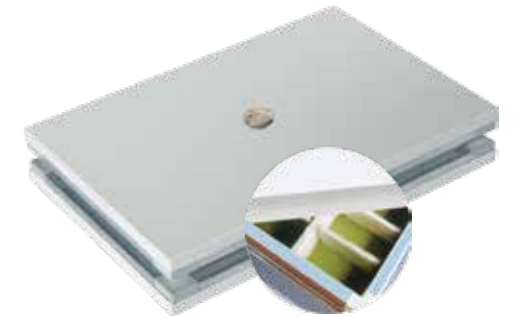

## HANDMADE POLY URETHANE COMPOSITE PANEL 聚氨酯手工夹芯板

### 产品介绍：

采用聚氨酯 PU 为芯材，镀锌（不锈钢）或彩涂板钢为面层结合高强度粘剂，通过高速连续自动成型机加温、加压复合，经过修边、开槽、下料而成的新一代建筑装潢板材。广泛用于电子、生物、食品、制药、医院、军事等洁净建筑领域，尤其适用于高洁净级别的生产车间和仓库。

### PRODUCT INTRODUCTION:

The use of polyurethane PU as the core material, galvanized (stainless steel) or color coated steel for the surface layer of high strength adhesive, through high-speed continuous automatic molding machine heating, pressure composite, after trimming, slotting, A new generation of architectural decoration sheet.

Widely used in electronics, biological, food, pharmaceutical, hospital, military and other clean construction areas, especially for high clean level of the production workshop and warehouse.



## HANDMADE GYPSUM&PAPER(ALUMINUM) HONEYCOMB PANEL 玻镁纸蜂窝手工夹芯板

### 产品介绍：

手工双面玻镁纸蜂窝夹芯板，采用优质彩色涂层钢板为面层，用镀锌钢带为封边件及加强筋，用防潮玻镁板及纸蜂巢为芯层，通过加压、加热等工序制造而成，密封性能好，防火等级高。

### PRODUCT INTRODUCTION:

Manual double-sided glass magnesium paper honeycomb sandwich panels, the use of high-quality color coated steel sheet for the surface layer, with galvanized steel strip for the edge pieces and ribs, with moisture-proof glass board and paper honeycomb for the core layer, Heating and other processes made of good sealing performance, high fire rating.

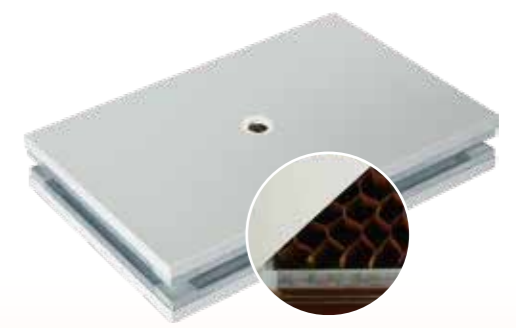



## HANDMADE GYPSUM&PAPER(ALUMINUM) HONEYCOMB PANEL 玻镁铝蜂窝手工夹芯板

### 产品介绍：

手工双面玻镁铝蜂窝夹芯板，采用优质彩色涂层钢板为面层，用防潮玻镁板及铝蜂窝为芯层，用特制龙骨支撑，经加温、加压、固化后制成。芯材采用独特六边形结构，具有高抗压强度，张力好，属于绿色环保建材，是目前洁净厂房推广的环保型板材。重量轻，平直度好，外形美观，节点科学。隔热保温，导热系数 $\leq 0.030\text{m.k}$ ，防火时间 $\geq 60\text{min}$ 。

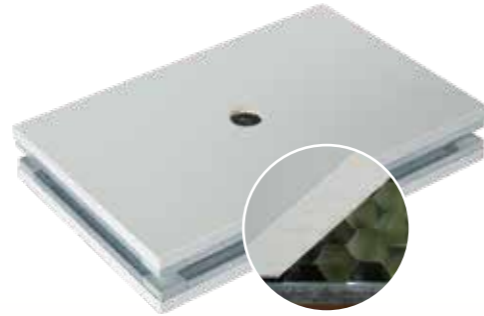

### PRODUCT INTRODUCTION:

The handmade double faced magnesium aluminum honeycomb sandwich panel is made of high quality color coated steel plate, and is made of damp proof glass magnesium plate and aluminum honeycomb core, and is made of special keel, which is made by heating, pressurizing and curing. The core material adopts the unique hexagonal structure, has high compressive strength and good tension, belongs to the green environmental protection building material, and is an environment-friendly plate popularized by the clean factory building at present. Light weight, good flatness, beautiful appearance, node science.

Insulation, thermal conductivity is less than or equal to  $0.030\text{m.k}$ , the fire time is no less than 60min.

## HANDMADE SILICON ROCK COMPOSITE PANEL 硅岩手工夹芯板

### 产品介绍：

手工硅岩夹芯板，采用优质彩色涂层钢板为面层，用镀锌钢带为封边件及加强筋，用无机材料（二氧化硅、硫氧镁等）与有机材料结合而成的硅岩为芯层，通过加压、加热等工序制造而成，密封性能好，防火等级高。

- 质地轻：其容重在80-400kg/m<sup>3</sup>之间；
- 隔音性能好：隔音性能是普通隔墙的5-8倍；
- 耐高温性能好：耐高温1500℃以上

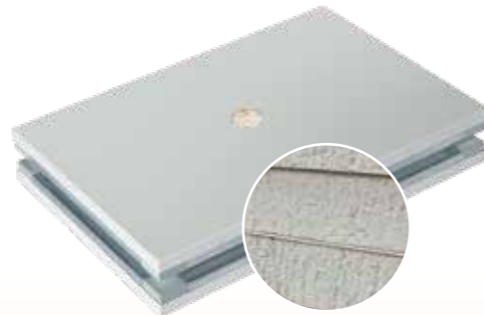

### PRODUCT INTRODUCTION:

Manual silicalite sandwich board, using high-quality color coated steel plate as a surface layer, with galvanized steel strip for sealing parts and reinforced with inorganic materials (silica, magnesium oxychloride etc.) and organic materials with siliceous rocks as the core layer, formed by pressure and heating process, good sealing performance, fire prevention high grade.

- Light texture: its bulk density is between 80-400kg/m<sup>3</sup>;
- Sound insulation property is good: the sound insulation performance is 5-8 times of ordinary partition wall;
- High temperature resistance: high temperature above 1500

## BOILING STONE HANDMADE SANDWICH PANELS 沸腾石手工夹芯板

### 产品介绍：

• 彩涂板+沸腾石+彩涂板手工制作。沸腾石又称是以沸腾石、玻化微珠、纤维素纤维、无机粘结剂等原料配制、加压成型、烘干等工序而制成的新一代环保型防火保温芯材板。

- 优点：耐高温、防火性能好。
- 应用：广泛应用于食品、制药、电子、科研、航天、医疗等行业的厂房、实验室及各种场所功能性隔断及吊顶、尤其适用于高温、防火要求高的车间、仓库等。

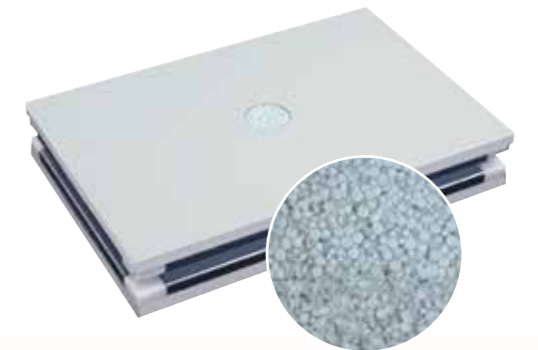

### PRODUCT INTRODUCTION:

• Color coated board + boiling stone + color coated board handmade. Boiling stone, also known as boiling stones, vitrified beads, cellulose fiber, inorganic binder and other raw materials preparation, press molding, drying and other processes made of a new generation of environmentally friendly fire insulation core board.

- Advantages: high temperature, good fire performance.
- Application: Widely used in food, pharmaceutical, electronics, scientific research, aerospace, medical and other industries of the plant, laboratory and various places functional partition and ceiling, especially for high temperature, fire demanding workshop, warehouse and so on.

## PHENOLIC HAND SANDWICH PANELS 酚醛手工夹芯板

### 产品介绍：

• 构成：彩涂板+酚醛芯材+彩涂板，采用手工制作工艺。酚醛泡沫素有“保温材料之王”的美称，是新一代保温防火隔音材料。它具有轻质、防火、遇明火不燃烧、无烟、无毒、无滴落，使用温度范围广。

- 优点：绝热、防火性能好。
- 应用：广泛应用于食品、制药、电子、科研、航天、医疗等行业的厂房、实验室及各种场所功能性隔断及吊顶、尤其适用于温度要求高、防火要求高的车间、仓库等。

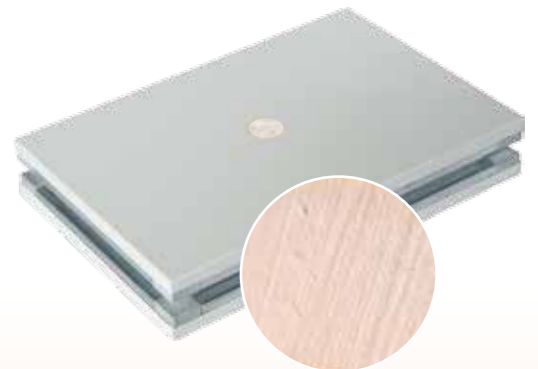

### PRODUCT INTRODUCTION:

• Composition: color coated board + phenolic core material + color coated board, using hand-made process. Phenolic foam has "the king of insulation materials," the name, is a new generation of thermal insulation materials insulation. It has a light, fire, case of fire does not burn, smoke-free, non-toxic, no dripping, the use of a wide temperature range.

- Advantages: adiabatic, fire performance.
- Application: Widely used in food, pharmaceutical, electronics, scientific research, aerospace, medical and other industries plant, laboratory and various places functional partition and ceiling, especially for high temperature requirements, high fire requirements of the workshop, warehouse and so on.

INNOVATIVE  
TECHNOLOGY

创新技术 拼接处留缝  
打胶密封性更好

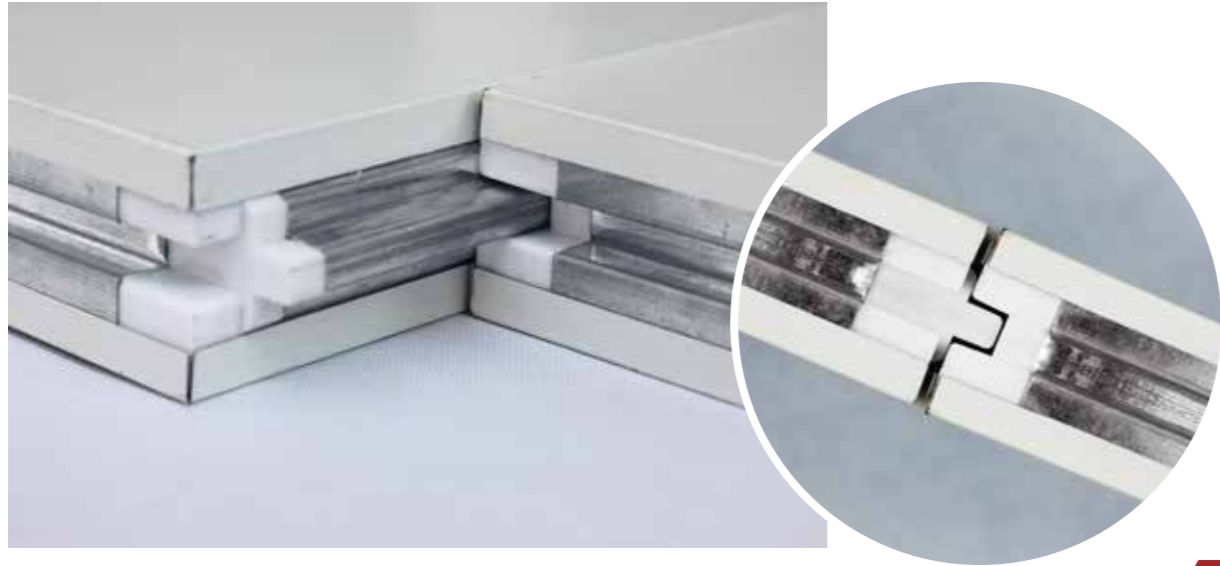

净化板材  
拼接方式

PURIFICATION  
OF SHEET  
METAL STITCHING



MIDDLE PLACE TYPE  
SPLICE MANNER

中置式连接

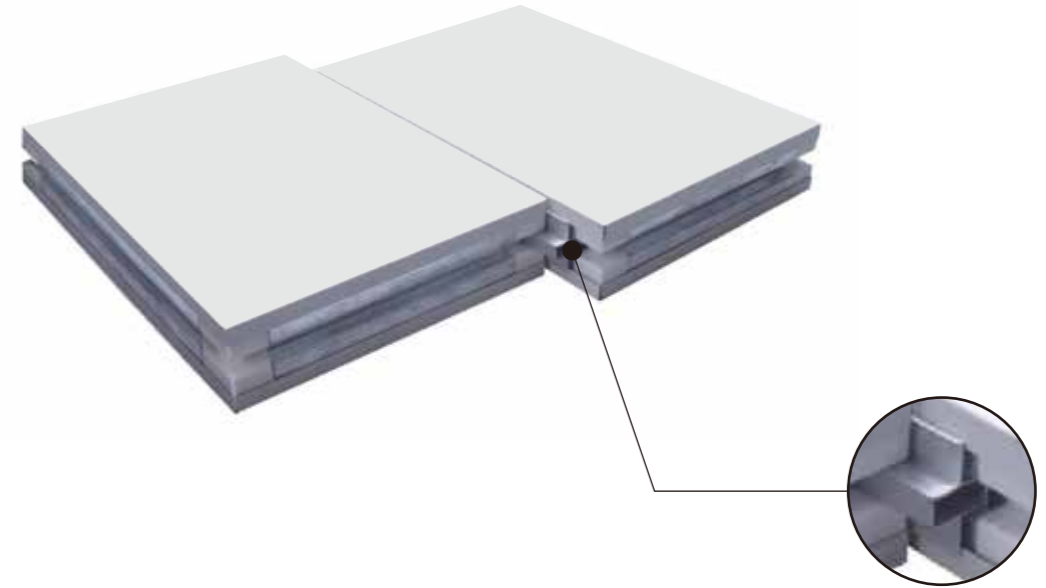

- 采用中字铝连接，安装方便、便捷。
- 四周采用弓字型镀锌龙骨，整板强度更大。
- 吊顶板采用四周重型中字吊梁强度更大。
- 模块式组装、施工更快捷。
- The use of aluminum in connection, easy to install and convenient.
- Around the bow-shaped galvanized keel, full strength even more.
- Hanging heavy around the roof hanging beam intensity even more.
- Module, Assembly, construction faster.

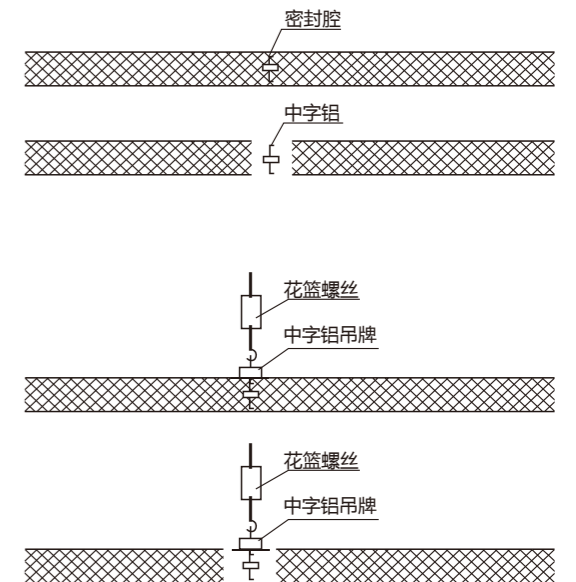



## TONGUED AND GROOVED TYPE SPLICE MANNER 企口式连接



- 采用子母口插接方式，有效降低了安装成本。
- 每一个企口内部都可以做为穿线管道，方便施工。
- 七线外90°压制，插缝更美观。
- 均属于墙板、顶板的理想板型。
- The use of letters dock, effectively reducing the installation costs;
- Every enterprise can do for threading pipe to facilitate construction;
- Lines 90 ° pressed, plug gap more beautiful;
- Are ideal for siding, roof form.

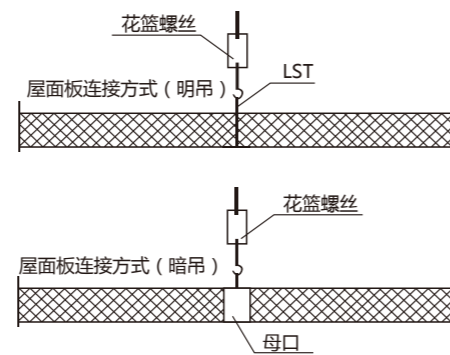
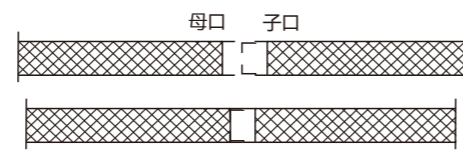

## MIDDLE PLACE TYPE SPLICE MANNER 中字式连接

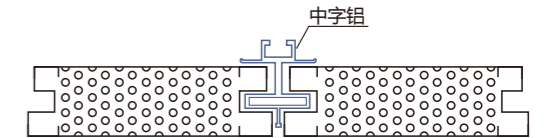

## INSERT TYPE SPLICE MANNER 插入式连接

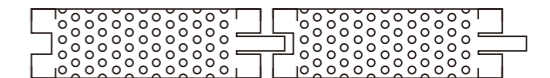
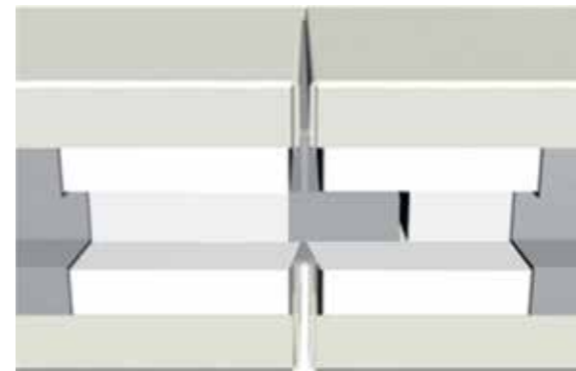



# 净化产品 PURIFICATION PRODUCTS

## AIR SHOWER 风淋室

风淋室是一种通用性较强的局部净化设备，安装于洁净室与非洁净室之间的隔墙处，用于人员或物体进入洁净区时的吹淋除尘。使用后可有效和减少尘源进入洁净区，使洁净区保持正常的工作状态。

广泛适用于食品饮料、电子、医药卫生等各种行业及科研领域。

As a kind of local purification equipment with versatility, it is installed at the partition wall between clean room and non-clean room, and used for showering and removing dust when personnel or objects are entering clean area. After use, it can effectively reduce the dust entering clean area and make the clean area keep normal working conditions.

It is widely used in various industries (including food and beverage, electronics, medicine & health, etc.) and scientific research field.



感应门风淋室  
Induction door air shower

风淋室按材质可分为三大类：

- 彩钢板风淋室
- 钢板风淋室
- 全不锈钢风淋室

THERE ARE THREE TYPES OF AIR SHOWERS BY MATERIAL:

- Color steel plate air shower
- Steel plate air shower
- Stainless steel air shower

按类型可分为三大类：

- 人淋室
- 货淋室
- 通道风淋

THERE ARE THREE TYPES OF AIR SHOWERS BY USAGE:

- Man-oriented shower
- Cargo-oriented shower
- Channel air shower



不锈钢风淋室  
Stainless steel air shower



单人双吹风淋室(钢板)  
Single-person and double-blowing air shower (steel plate)



双人双吹风淋室(不锈钢门)  
Double-person and double-blowing air shower (stainless steel door)



## CLEAN PASS BOX 洁净传递窗

传递窗是一种洁净室的辅助设备，主要用于洁净区与洁净区之间、洁净区与非洁净区之间小件物品的传递，以减少洁净室的开门次数，把对洁净室的污染降低到最低程度。

主要分为三大类：电子连锁传递窗，机械连锁传递窗，自净式传递窗。

As a kind of auxiliary equipment for clean room, it is mainly used to transfer small objects between clean rooms and non-clean rooms in order to reduce the frequency of door opening and minimize the pollution to clean room.

It can be classified to three types: Electronic interlocking pass box, mechanical interlocking pass box and self-cleaning pass box.



类型	内径	外形
机械连锁传递窗(宽x高x深)	600x600x600	720x680x660
电子连锁传递窗(宽x高x深)	600x600x600	720x680x660
自净式传递窗(宽x高x深)	600x600x600	720x1100x660

注：接受客户具体要求订货！

## CLEAN LAMINAR FLOW HOOD 洁净层流罩

WCZ壁板式洁净层流罩可灵活地吊装在需要洁净度的工艺点上方，以满足局部高洁净度的要求。可单独使用，也可多个连接组成带状洁净区域；与土建室或装配式百级洁净室相比，投资少、见效快、安装简便、运行费用低。

WCZ wall plate type clean laminar flow hood can be flexibly installed above the process point requiring cleanliness in order to meet high requirements for local cleanliness. It can be used separately or many hoods can be used to form strip-based clean area; compared with civil engineering room or assembling type clean room (Class 100), it is characterized by small investment, quick effect, easy installation and low operation cost.



型号	外型尺寸 AxBxH(mm)	工作尺寸 axb(mm)	吊装尺寸 CxD(mm)	额定风量 m <sup>3</sup> /h	高效过滤器		照明灯数	功耗 Kw	重量 Kg
					尺寸 (mm)	数量			
WCZII-1220/610	1360x740x750	1220x610	1220x600	1200	610x610x90	2	1	1	~120
WCZII-1220/915	1360x1040x750	1220x915	1220x900	1800	915x610x90	2	1	1	~170
WCZII-1830/610	1970x740x750	1830x610	1830x600	1800	610x610x90	3	2	2	~170
WCZII-1830/915	1970x1040x750	1830x915	1830x900	2400	915x610x90	3	2	2	~220
WCZII-2440/610	2590x740x750	2450x610	2450x600	2400	610x610x90	4	2	3	~220
WCZII-2440/915	2590x1040x750	2450x915	2450x900	3000	915x610x90	4	2	3	~270

## HIGH-EFFICIENT AIR DISTRIBUTOR 高效送风口

高效送风口的外壳用优质冷轧钢板制作，表面静电喷塑，含静压箱，高效过滤器，散流板，在改建和新建各级洁净室，可作为终端高效过滤装置在洁净顶棚等处，具有投资少，施工简便等优点。

●静压箱采用低碳钢材料制作，高效过滤器和静压箱做成一个整体。在静压箱的进风口处配置，调节阀调节送风均匀度和静压效果。

●重量轻、安装、更方便，尤其适合安装于铝合金龙骨形式的洁净室中。

With enclosure made of high quality cold-rolled steel plate and surface electrostatic spray, high-efficient air distributor is composed by static pressure box, efficient filter and diffuser plate. For rebuilt and newly built clean rooms with various classes, it can be installed at the clean ceiling as terminal and efficient filter device, characterized by small investment and easy construction.

● Static pressure box is made of low carbon steel material. After efficient filter and static pressure box are assembled as a whole, it is provided at the air inlet of static pressure box and the regulating valve is used to regulate air supply uniformity and static pressure effect.

● Characterized by lightweight and easy installation, it is especially suitable for installing in the clean room with aluminum alloy keel.



高效送风口  
High-efficient air distributor



不锈钢高效送风口  
High-efficient stainless steel air distributor

## FFU UNIT FFU机组

●风机采用德国EBM直驱式高效离心风机，具有寿命长、噪声低、免维护、震动小、可无极调速等特点性，风机质量可靠，工作寿命长达5万小时以上。

●特别适合于组装机超净生产线，可根据工艺需要布置为单台使用，也可将多台串联形成100级流水装配线。

●壳体结构选用不锈钢、铝合金、冷轧钢板材料制造，重量轻、抗腐蚀、防锈、美观大方。

●产品出厂前均按美国联邦标准209E，用尘埃粒子计数器逐台扫描检测，确保质量。

● Germany EBM direct-driven efficient centrifugal fan is used and characterized by long service life, low noise, free-maintenance, small vibration and stepless speed regulation. The fan has reliable quality and can work for more than 50,000 hours.

● It is especially suitable for assembling type ultra-clean production line. In accordance with process requirements, it can be used separately or many sets can be connected in series to form flow assembly line (Class 100).

● Enclosure structure is made of stainless steel, aluminum alloy and cold-rolled steel plate materials, and characterized by lightweight, corrosion resistance, anti-rust and beautiful appearance.

● In accordance with US federal standard 209E, the products shall be scanned and inspected with dust particle calculator one by one in order to ensure quality before leaving the factory.



大规格FFU  
Large-sized FFU



## NEGATIVE PRESSURE WEIGHING CHAMBER 负压称量室

称量室是一种用于制药、微生物研究和科学实验等场所专用的局部净化设备，它提供一种垂直单向气流。部分洁净空气在工作区循环，部分排出至附近区域，使工作区产生负压。在设备中进行粉尘、试剂称量、分装，可以控制粉尘、试剂外溢、上扬，防止粉尘、试剂对人体的吸入危害，还可避免粉尘、试剂的交叉污染，保护外界环境及室内人员的安全。

As a kind of local purification equipment specially used for many fields such as pharmacy, microorganisms research and scientific experiment, it will provide vertical unidirectional airflow. Some clean air is circulated in the working area and some air is exhausted to the nearby area so as to produce negative pressure in the working area. Weighing and sub-packaging for dust and reagent are conducted within this equipment in order to control spillover and flying of dust and reagent, prevent human body from inhalation hazard caused by dust and reagent, avoid cross contamination between dust and reagent and protect external environment and the safety of indoor personnel.



外型尺寸	洁净等级	照度	风速	全压	额定风量	总功率
按照客户尺寸定做	A级	≥300LUX	0.35-0.5m/s	500Pa	根据尺寸计算	按照设计要求
调速	高效过滤器	整体材质	保护对象			
变频器(调节频率)	反法兰液槽过滤器	SUS304#	药品、操作人员、工作环境			

注：可根据客户要求，非标定制产品。

## CLEAN BENCH 洁净工作台

洁净工作台以空气流向可分为水平层流和垂直层流两大形式，在这两大形式下形成了标准型、医用型、新颖型、分离套入型、桌上型、生物型等9个品种、30个型号规格。根据不同的功能与特点，分别应用于医疗卫生、电子机械、仪器仪表、食品制药、植物组培、生物工程、畜牧兽医、大专院校等领域和各类实验室。

It can be classified into two forms including horizontal laminar flow and vertical laminar flow in accordance with airflow direction. Based on this two forms, there are 9 types (including standard type, medical type, novelty type, separating and inserting type, desktop type, biological type, etc.) and 30 models. In accordance with different functions and features, it can be used in many fields (such as medical health, electro-mechanical, instrument and apparatus, food and medicine, plant tissue culture, bioengineering, animal husbandry and veterinary, universities and colleges) and various laboratories.

### 医用型工作台 MEDICAL TYPE BENCH



参数		型号	YJ-875	YJ-1450
规格			单人单面	双人单面
规格尺寸	外形	宽×深×高 W×D×H (mm)	1005x700x1650	1620x700x1650
	工作区	宽×深×高 W×D×H (mm)	875x700x460	1450x700x460
高效过滤器规格及数量			820x600x50x1	600x600x50x1 820x600x50x1
特点及用途			准闭合台面，可调风量风机，进口不锈钢台面，带紫外灯，主要用于医疗卫生、制药、化学实验室。	

注：接受客户具体要求订货！

### 标准型工作台 STANDARD TYPE BENCH



参数		型号	SW-CJ-1A	SW-CJ-2A
洁净等级			100级(≥0.5μm≤3.5粒/L)	
平均风速			0.3~0.6m/s(可调)	
噪声			≤62dB(A)	
振动半峰值			≤3μm	
柜内气流			水平单向流	
照度			≥300Lx	
电源			AC，单相220V/50Hz	
最大功耗			0.4KW	0.8KW
规格尺寸	外形	宽×深×高 W×D×H (mm)	900x720x1450	1620x700x1450
	工作区	宽×深×高 W×D×H (mm)	875x480x620	1450x480x620
高效过滤器规格及数量			820x600x50x1	600x600x50x1 820x600x50x1
荧光灯/紫外线灯规格及数量			20Wx1/x20Wx1	40Wx1/x40Wx1
备注			单人单面	双人单面



# PURIFY DOORS & WINDOWS

## 净化门窗

净化门其外观精美，坚固耐用，开启灵活。用户根据要求选用铝合金材料、不锈钢材料和自动封闭装置，以防止昆虫和其他小动物进入洁净厂房，还可以任意选定可视窗型式、尺寸以及门板颜色和门锁型号。

Purify door, its appearance is exquisite, durable, open and flexible. Aluminum alloy materials, stainless steel materials and automatic sealing devices are selected to prevent insects and other small animals from entering the clean plant, and the type and size of the window, the color of the door plate and the type of door lock can be selected.



自由门  
Free door

快速卷帘门  
Fast shutter doors



医用门  
Medical door

钢制双开净化门  
Steel double open purge door

自由门  
Free door

钢制门  
Steel door

钢制单开净化门  
Steel making single open purge door



自动门  
Automatic Door

铝合金净化门  
Aluminum alloy cleaning door

全不锈钢净化门  
All stainless steel purge door

钢制单开净化门  
Steel making single open purge door

净化窗按材质可分为：

铝合金框成品窗、不锈钢框成品窗、一次成形钢制框成品窗；

按外形可分为：

圆角边成品窗、方形边成品窗；均为双层中空玻璃，密封性能、保温隔热性能好。

According to the material, the cleaning window can be divided into:

Aluminum alloy frame finished windows, stainless steel frame finished windows, one finished steel frame finished windows.

According to the shape, it can be divided into:

Fillet side finished windows, square side finished windows, all are double deck hollow glass, sealing performance, heat preservation and heat insulation performance is good.





## 售后服务 AFTER-SALE SERVICE

- 及时响应：承诺6小时响应客户需求
- 技术领先：实现质量标准达到国家防火等级要求认证
- 资质：国立净化所具备的多项国内和国外的资质认证
- 服务：围绕行业标准 国家政策及时提供升级方案

国立净化严格执行ISO质量管理体系之要求，致力于具有技术精湛，作风过硬的产品生产、设计、安装队伍的培养，保证产品质量与工程质量满足客户要求，并在工程项目执行期间及项目完成后提供高质量的服务，为创造一个舒适、洁净、健康、安全的工作生活空间而不懈努力。期待与您建立相互信任，真诚合作的良好关系，秉承传统、创造经典，让我们同耕耘、同成长，幸福收成同分享。

- Timely response: Promising to make response to customer demands within 6 hours
- Leading technology: Reaching quality standard and achieving national fire-proof grade certification
- Qualification: Having many domestic and foreign qualification certifications
- Service: Focusing on industry standard and national policy and providing upgrading plan timely

National Purification strictly implements ISO quality management system requirements, applies itself to cultivating production, design and installation teams with excellent skills and good working style, ensures that product and engineering quality will meet customer requirements, provides high quality services during project implementation and after project completion, and spares no effort to create comfortable, clean, healthy and safe working and living spaces for you. We are looking forward to establishing mutual trust and sincere cooperation with you. In addition, we will always adhere to our traditions, strive to create classics and sincerely hope to grow up and make sharing with you together.

# AFTER-SALE SERVICE